



KIT

Alle Möbel von PALMBERG garantieren eine 100% fugenlose Kantenverarbeitung durch Lasertechnologie auf höchstem Niveau. Unsere Produktion unterliegt dabei den strengen Anforderungen des Qualitätsmanagements ISO 9001:2008, dem Umweltmanagement ISO 14001:2004 und der EG-Ökoauditverordnung.

Mit PALMBERG freuen Sie sich aufs Büro!

All pieces of furniture from PALMBERG guarantee 100% joint-less edge processing by means of laser technology at the highest stage. Our production is subject to the strict requirements of the Quality Management ISO 9001:2008, the Environmental Management ISO 14001:2004 and the EC Eco-Management and Audit Scheme.

With PALMBERG you're looking forward to the office!

Alle meubels van PALMBERG garanderen een 100% voegloze kantverbinding door lasertechnologie van het hoogste niveau. Wij produceren volgens de strenge eisen van het kwaliteitsmanagement ISO 9001:2008, het milieumanagement ISO 14001:2004 en de EG Ecoauditverordening.

Met PALMBERG is het plezierig werken!

Die neue Lasertechnologie eröffnet ungeahnte Potenziale im Prozess der Kantenverarbeitung und schafft ein qualitativ hochwertiges Produkt, das neue Maßstäbe in Sachen Qualität und Design setzen wird.

Ihre Vorteile:

- Sichtbare Kleberfuge entfällt
- Homogene Werkstückoptik durch Nullfuge
- Keine Klebe- oder Schmutzrückstände im Kantenbereich
- Verbesserte Feuchtigkeitsbeständigkeit in der Verbindung von Kante und Platte
- Erhöhte Wärmebeständigkeit in der Verbindung von Kante und Platte
- Keine Einschränkungen hinsichtlich Farb- und Dekorplatte

 laser



Ein „Kantensprung“ für Ihre Arbeitswelt

Cutting-edge development leap for your working world

Een enorm kwaliteitsvoordeel voor uw kantooromgeving



The new laser technology opens up new perspectives of edge processing and so creates a high-quality product that will set new standards in the matter of quality and design.

Your advantages:

- No visible glue joint
- Homogenous look of the work piece by zero-joint
- Fewer residues of glue or dirt in the edge area
- Improved moisture resistance at the connection of edge and board
- Increased thermal stability at the connection of edge and board
- No limitations with regard to the range of colours and decors

De nieuwe lasertechnologie biedt een nieuw potentieel in het productieproces van de kantenband verwerking en creëert hierdoor een kwalitatief hoogwaardig product, dat een nieuwe standaard inzake kwaliteit en design zal bepalen.

Uw Voordelen:

- De zichtbare voeg verdwijnt
- Homogeen beeld van het materiaal door onzichtbare voeg
- geen lijm resten en vuiligheid in de voegen
- Verbeterde weerstand tegen vocht in de verbinding van kantenband en plaatmateriaal
- Verbeterde warmteweerstand in de verbinding van kantenband en plaatmateriaal
- Geen beperking betreffende de kleuren en decors



KIT | 4

KIT – Baut Brücken für Ihre Kommunikation
KIT – builds bridges for your communication
KIT – Bouwt de brug voor uw communicatie

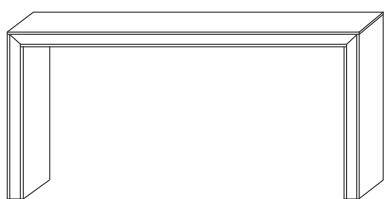

freistehend
freestanding
vrijstaand



aufgedockt
resting
opgedokt

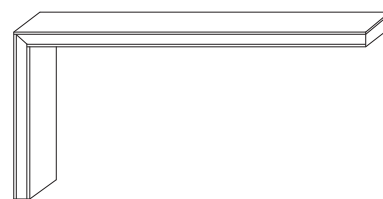

Wandmontage
wall mounting
wandmontage

Ob kleine Stehbesprechung, Laptop-Präsentation oder kurze Kaffeepause – alles ist möglich. KIT ist in verschiedenen Höhen, Breiten und Tiefen erhältlich. Die Brücke ist als freistehende Lösung genauso praktikabel wie auch als wandgebundenes Element. Dabei ist KIT voll elektrifizierbar und bietet alle relevanten Schnittstellen zur modernen Medienwelt.

Whether small standing conference, laptop presentation or short coffee break – the sky's the limit. KIT is available in different heights, widths and depths. The bridge is feasible, no matter if freestanding solution or mounted element at the wall. KIT allows full electrification and provides every relevant interface to the modern world of media.

Korte stavergadering of laptop presentatie of korte koffiepauze – alles is mogelijk. KIT is compleet bekabelbaar en biedt alle belangrijke aansluitingen voor de moderne mediawereld. KIT is in verschillende hoogtes, breedtes en dieptes verkrijgbaar. Het kan vrijstaand geplaatst worden en is ook als muurverbonden element verkrijgbaar. KIT is compleet bekabelbaar en biedt alle belangrijke aansluitingen voor de moderne mediawereld.





KIT - Frei im Raum

KIT ist die Brücke für Ihre Kommunikation. Dort, wo Menschen zusammen kommen, entsteht meist Kreativität gepaart mit guter Laune. Kreuzen Sie mal im Büro auf!

KIT - Open in the space

KIT is the bridge for your communication. Where people come together, creativity, usually coupled with good mood, comes into being. Why don't you turn up in the office?

KIT - Vrij in de ruimte

KIT is de brug voor uw communicatie. Daar waar mensen samenkomen, ontstaat meestal creativiteit, welke gepaart gaat met een goed humeur.







KIT – Immer oben auf!

Sideboards der Serie SELECT und KIT bilden ein ideales Paar, wenn es darum geht, Steharbeit und Stauvolumen zu vereinen. Die aufgedockte KIT-Lösung ist frei positionierbar und bietet so auch Konstellationen jenseits des rechten Winkels.

KIT – Always on top!

Sideboards of the series SELECT and KIT are an ideal couple when it comes to combining standing work with storage volume. The KIT on-top-solution is freely positioned and also offers constellations beyond the right angle.

KIT – Altijd on-top!

Sideboards van de serie SELECT en KIT vormen een ideaal koppel, als het draait om staand werk en volumes te verenigen. De opdock oplossing van KIT kun je in alle posities plaatsen en biedt zo ook andere dan alleen maar 90 graden opstellingen.



Natürlich ist es auch möglich, die KIT-Brücken wandgebunden zu nutzen.

Of course, it's possible to use the KIT bridges wall-mounted.

Het is natuurlijk ook mogelijk, de KIT-bruggen als wandelement te gebruiken.

Mit KIT an die Wand · With KIT onto the wall · Met KIT tegen de wand

Verstauen Sie ihr technisches Equipment doch in der KIT-Schublade, bevor es zum Kabelsalat wird.

Why don't you stow your technical equipment in the KIT drawer before producing a mess of cables?

U kunt uw technische apparatuur het beste in de KIT-schuiflade opbergen, voordat het een kabelwirwar wordt.









Multifunktionale Raumlösung
Multifunctional space solution
Multifunctionele ruimteoplossing

Ob Nebeneinander oder Gegenüber – KIT bietet ausreichend Platz für einen intensiven Dialog und wird durch die Integration von Funktions- und Multimediaelementen zum modernen Kommunikationsmöbel.

15 | KIT

Whether next to or opposite – KIT provides enough space for an intense dialogue and becomes, integrating functional and multimedia elements, modern communication furniture.

Naast- of tegenover elkaar – KIT biedt voldoende ruimte voor een intensieve dialoog en wordt door de integratie van functien- en multimedia-elementen een modern communicatiemeubel.

DIMENSIONS

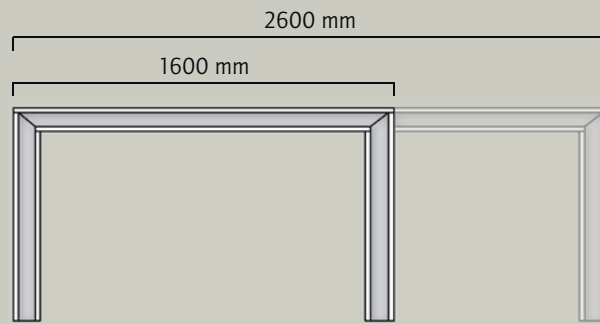

KIT passt sich Ihrem Raum an – mit unterschiedlichen **Breiten** von 1600 bis 2600 mm.

KIT adapts itself to your room – with different **widths** from 1600 to 2600 mm.

KIT past zich aan uw beschikbare ruimte aan – met verschillende **breedtes** van 1600 tot 2600 mm.



Die Brücken gibt es wahlweise mit **Höhen** von 913 oder 1105 mm.

The bridges are optionally available in **heights** of 913 or 1105 mm.

De bruggen zijn op de **hoogte** van 913 of 1105 mm verkrijgbaar.

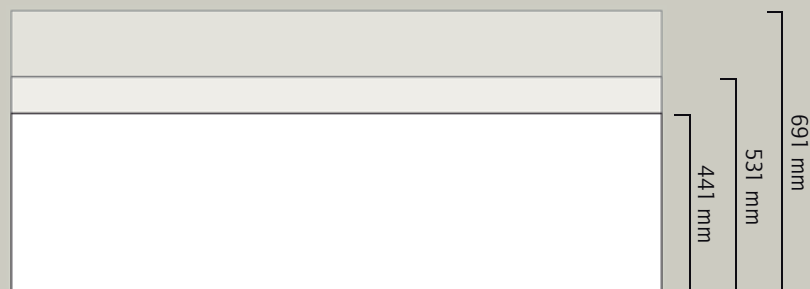

Ausreichend Platz bieten die drei wählbaren **Tiefen** von 441, 531 und 691 mm.

The selectable **depths** of 441, 531 and 691 mm provide sufficient space.

Voldoende ruimte bieden de drie verschillende **dieptes** van 441, 531 en 691 mm.

MEETING



Zur Montage an Wänden oder Schränken
For mounting at walls or cabinets
Voor montage aan de muur of aan een kast



Brücke zum Aufdocken auf Container oder Sideboards
Bridge for resting on containers or sideboards
Brug voor opdokken op ladeblokken of sideboards

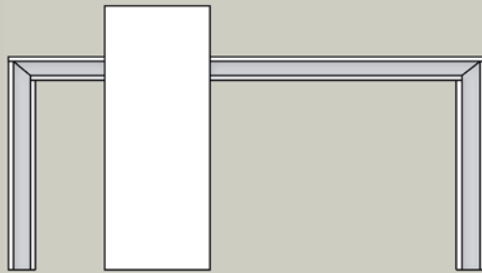

Zwei Höhen von 913 und 1105 mm über Kreuz
Two heights of 913 and 1105 mm crosswise
Twee hoogtes van 913 en 1105 mm kruislings



Brücke mit Schubladenschrank SELECT
Bridge with drawer cabinet SELECT
Brug met SELECT schuifladenkast

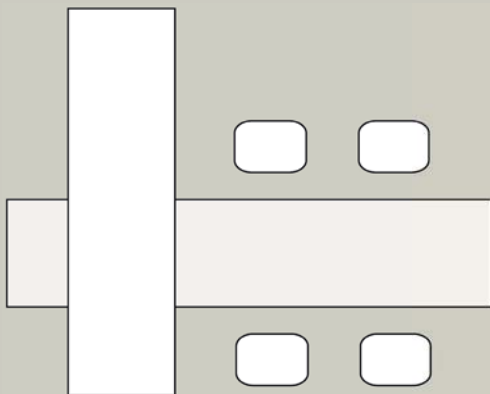

WORKING

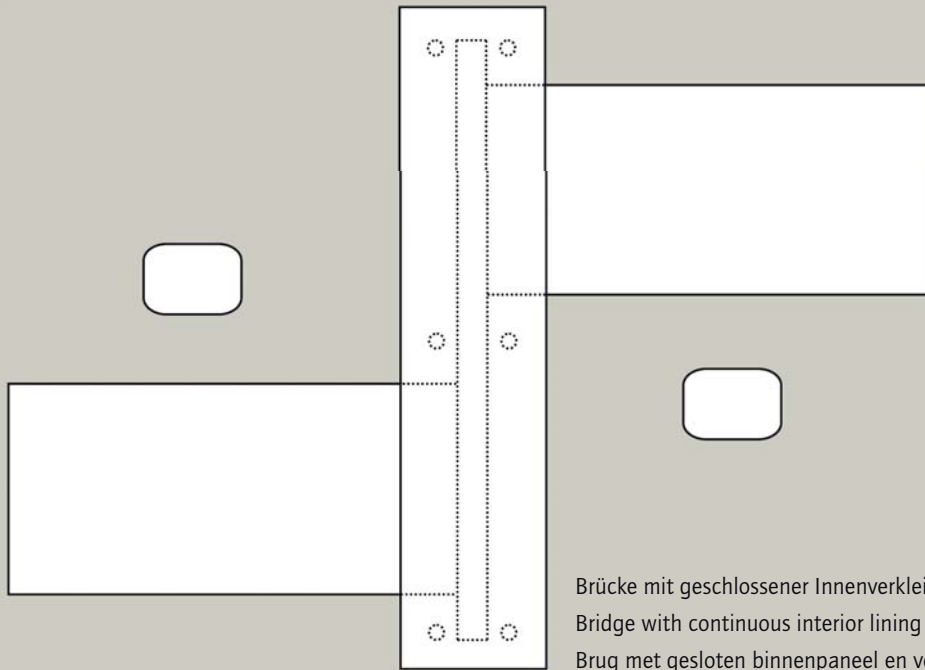

Brücke mit geschlossener Innenverkleidung und Beleuchtung
Bridge with continuous interior lining and lighting
Brug met gesloten binnenpaneel en verlichting



LED-Strahler
LED
LED-licht



Point
Point
Point



Kabeleinlassbuchse
Cable socket
Kabeldoorvoerdop

CATERING

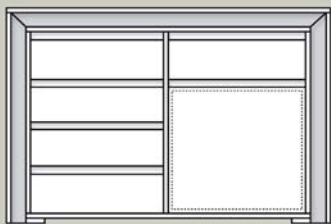

Brücke für Cateringumbau mit Schubladenschrank links und Frontauszug mit Abfallbehälter rechts

Bridge for catering modification with drawer cabinet left and front pull-out with waste bin right

Brug voor cateringombouw met schuifladenkast links en uittrekbaar front met afvallemmers rechts

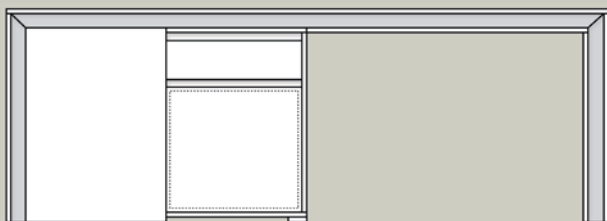

Brücke für Cateringumbau mit Kühlschrank hinter Schiebetür links und Frontauszug mit Abfallbehälter rechts

Bridge for catering modification with fridge behind sliding door left and front pull-out with waste bin right

Brug voor cateringombouw met koelkast achter schuifdeur links en uittrekbaar front met afvallemmers rechts

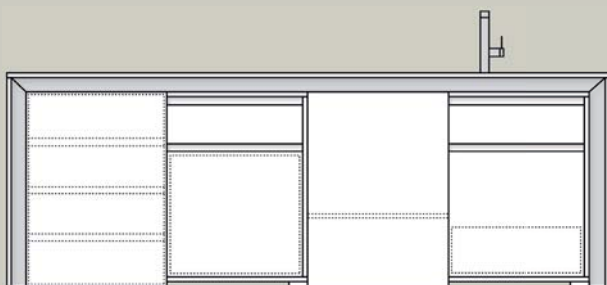

Brücke für Cateringumbau inkl. Oberboden mit Spüle und Armatur

Bridge for catering modification inclusive top board with sink and fittings

Brug voor cateringombouw incl. topblad met spoelbak en kraan





Mit KIT geht Ihnen ein Licht auf!
Lucid moments with KIT!
Met KIT gaat er bij u een lichtje branden!

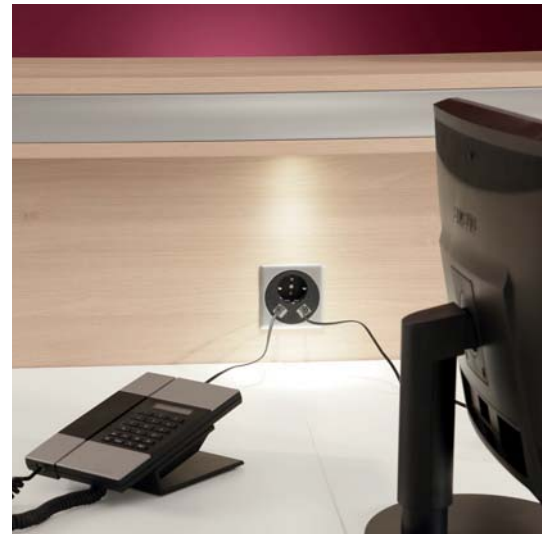



Die eingelassenen LED-Leuchten sorgen für angenehme Ausleuchtung am Arbeitsplatz.
Mit geschlossener Innenverkleidung entsteht aus KIT ein kleiner Empfang.

The embedded LED ensure a pleasant illumination at the workplace.
KIT becomes a small reception by means of a panel.

De ingebouwde LED-lampen zorgen voor een aangename verlichting bij je werkplek.
Met gesloten binnenwand ontstaat uit KIT een kleine ontvangstbalie cq separatie.



KIT | 24





1



2



3

KIT | 26

Treffpunkt Küche

Sie wollen KIT zum zentralen Möbel in Ihrer Mittelzone machen? Kein Problem! Mit einigen Extras wird aus KIT die perfekte Büroküche. Die Laserkanten verhindern dabei das Eindringen von Feuchtigkeit.

Meeting point kitchen

You want to make KIT the central furniture in your mid-zone? No problem! By some extras, KIT becomes the perfect office kitchen. Moisture is being prevented from entering by the laser edges.

Trefpunt keuken

U wilt KIT als centraal cateringmeubel opstellen? Geen probleem! Met een paar extras ontstaat uit KIT de perfecte kantoorpantry. De laserkanten zorgen ervoor dat er geen vocht naar binnen dringt.

 laser

vorherige Seite · previous page · vorige pagina:

Hinter den vorlaufenden Schiebetüren ist genügend Platz für Geschirrspüler und Kühlschrank · There is sufficient space behind the sliding doors for dishwasher and fridge · Achter de zwevende schuifdeuren is genoeg ruimte voor vaatwasser en koelkast

- 1 Hängeschrank mit Glasschiebetür · Wall cabinet with glass sliding door · hangkast met glazen schuifdeur
- 2 Spüle aus Edelstahl mit Armatur · Sink made of stainless steel with fixed drain · Spoelbak uit RVS met waterkraan
- 3 Frontauszug mit Besteckeinsatz oben · Front pull-out with cutlery organiser top · Bovenste schuiflade met bestekindeling
- 4 Frontauszüge mit Filzeinlage oben und unten · Front pull-out with felt insert top and bottom · Bovenste en onderste schuiflade met viltbekleding
- 5 Frontauszug mit Abfallbehälter unten · Front pull-out with waste bin bottom · Onderste schuiflade met afvallemmer
- 6 Point zur Elektrifizierung · Point for electrification · Point voor elektrificatie





Ob im Office- oder Gastronomiebereich, unser Loungewagen bietet Ihnen genug Stauraum für Ihr Catering-Equipment.

Whether in the office or catering area, our lounge trolley offers you sufficient storage space for your catering equipment.

Of het nu in het kantoor- of in het gastronomische bereik is, onze catering-wagen biedt u genoeg opbergruimte voor uw cateringuitrusting.





KIT | 30

Bitte ablegen!
Please take off!
Aflegen alstubleift!

Mit unserer neuen Garderobenausführung haben wir eine gleichermaßen platzsparende wie auch kreative Lösung für das Ablegen von Mänteln, Schals und Taschen entwickelt. Die multifunktionale Lösung, wahlweise als festes oder drehbares Garderobenelement, versteckt ihre Funktionen gerne und spart dabei noch ausreichend Platz. Ob mit fester oder klappbarer Garderobenstange oder mit funktionalen Garderobenklapphaken, unsere Ablage bietet genügend Platz für Ihr tägliches Outfit.



With our new coat rack design we have developed a creative solution with minimum space requirements for the placement of coats, scarves and bags. The multifunctional solution, optionally as fixed or hinged wardrobe element, likes hiding its functions and is even saving sufficient space. Whether with fixed or folding rod, or with functional folding coat hooks, our rack provides sufficient space for your daily outfit.

Met onze nieuwe garderobeuitvoering hebben we tegelijkertijd een plaatsbesparende maar ook creatieve oplossing voor het opbergen van mantels, sjaals en tassen ontwikkelt. De multifunctionele garderobeoplossing, verkrijgbaar als vast of draaibaar garderobe-element, verstopt haar functies en spaart daarbij ook nog veel plaats. Of het nu met vaste of klappbare garderobestang, of met functionele garderobe-klaphaken is, onze garderobe biedt genoeg plaats voor uw dagelijkse outfit.



Weiß matt
White matt
wit mat

Glastüren, Garderoben

Glass doors, coat rack
Glasdeuren, garderobe



Chrom Silber
Chrome silver
chrom zilver



Rot metallic
Red metallic
rood metallic



Cupritbraun
Cuprit brown
cuprit bruin



Granitgrau
Granite grey
graniet grijs



Schwarz
Black
zwart



Olivgrün
Olive green
olijfgroen



Weiß matt
White matt
wit mat

Glaserböden

Glass top shelves
Glazen topladen



Chrom Silber
Chrome silver
chrom zilver



Rot metallic
Red metallic
rood metallic

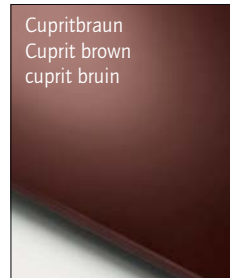

Cupritbraun
Cuprit brown
cuprit bruin



Granitgrau
Granite grey
graniet grijs



Schwarz
Black
zwart

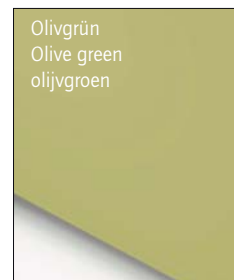

Olivgrün
Olive green
olijfgroen

Greifraumprofile · Spatial handle profile · Verzonken profielgrepen

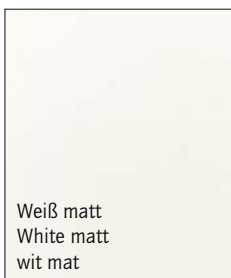

Weiß matt
White matt
wit mat

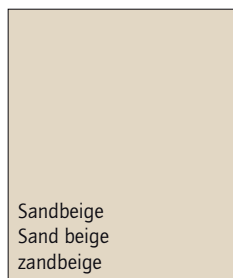

Sandbeige
Sand beige
zandbeige

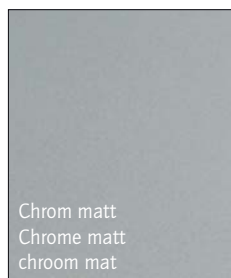

Chrom matt
Chrome matt
chrom mat



Granitgrau
Granite grey
graniet grijs



Schwarz
Black
zwart

Sockelfüße · Base elements · Hoeksokkels

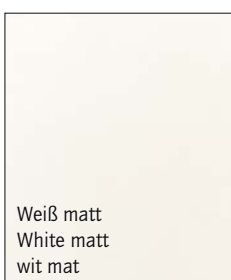

Weiß matt
White matt
wit mat

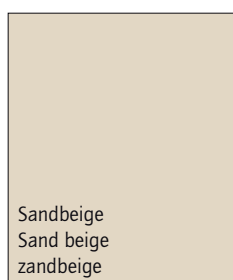

Sandbeige
Sand beige
zandbeige

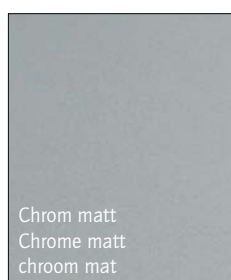

Chrom matt
Chrome matt
chrom mat



Granitgrau
Granite grey
graniet grijs

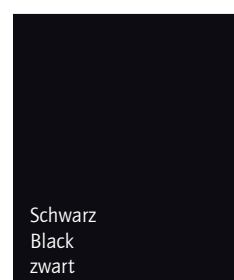

Schwarz
Black
zwart

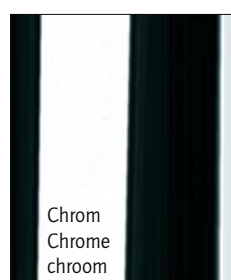

Chrom
Chrome
chrom

Volldekore · Full decors · Voldecors

 <p>Ahorn Maple ahorn</p>	 <p>Akazie Acacia acacia</p>	 <p>Buche gedämpft Beech muted gedempt beuken</p>	 <p>Birnbäum Pear peren</p>	 <p>toskan. Nussbaum Tuscan walnut toskaans noten</p>
 <p>Teak Rubin Teak ruby teak rubin</p>	 <p>Merano</p>	 <p>Nussbaum natur Natural walnut noten natuur</p>	 <p>Malaga Eiche Malaga oak malaga eik</p>	 <p>Zebrano</p>
 <p>Superweiß Super white superwit</p>	 <p>Grau perl Grey pearl Grijs parel</p>	 <p>Hanf perl Hemp pearl hanf parel</p>	 <p>Sandbeige Sand beige zandbeige</p>	 <p>Aluminium geschliffen Aluminium polished geslepen aluminium</p>
 <p>Anthrazit perl Anthracite pearl antraciet parel</p>	 <p>Vulkan schwarz Volcano black vulkaan zwart</p>	 <p>Olivgrün Olive green olijfgroen</p>	<p>Plattenstärke: 19 mm Tabletop thickness: 19 mm Plaatdikte: 19 mm</p>	

Erfahrungsgemäß können Druckfarben nicht die Brillanz der Dekor- und Gestellfarben wiedergeben. Gern wird Ihr Händler Ihnen Originalmuster vorlegen.

Experience has shown that the printed colors cannot reflect the brilliancy of the decoration and frame colors. Your dealer will be happy to present original samples.

Uit ervaringen blijkt dat de afgedrukte kleuren de brilliance van decor- en onderstelkleuren niet volledig weergeven. Uw dealer toont u graag de orginele kleuren.



KIT | 34



Das Warten hat sich gelohnt! KIT-Bänke und -Tische machen auch vor dem Office eine gute Figur.

Worth the wait! KIT benches and tables cut a fine figure also in front of the office.

Het wachten betaald zich uit! KIT-banken en tafels slaan ook voor het kantoor een goed figuur.



Natürliche Rauntrennung
Natural space separation
Natuurlijke ruimte indeling

Es gibt viele Möglichkeiten, Bereiche voneinander zu trennen. Mit den rollbaren KIT-Blumenkästen gelingt dies auf sympathische Weise.

There are a lot of options to separate areas from one another. Here, the KIT flower boxes on rollers succeed in a congenial way.

Er bestaan veel mogelijkheden om ruimtes te delen. De verrijdbare KIT-plantenbakken doen dit op een sympathieke wijze.



PALMBERG Büroeinrichtungen + Service GmbH
Am Palmberg 9 · D-23923 Schönberg
Tel. +49 38828 38-0 · Fax +49 38828 38-136
info@palmberg.de · www.palmberg.de

PALMBERG (Schweiz) AG
Niederlenzerstrasse 25 · CH-5600 Lenzburg
Tel. +41 62 888 80 00 · Fax +41 62 888 80 09
info@palmberg.ch · www.palmberg.ch

PALMBERG Büroeinrichtungen + Service GmbH
Rietveldeweg 47 · NL-5222 AP 's-Hertogenbosch
Tel. +31 411 689522 · Fax +31 411 689479
info@palmberg.nl · www.palmberg.nl

PALMBERG-Produkte werden ausschließlich über autorisierte Fachhändler angeboten, um Ihnen ein Höchstmaß an Service und Bürokompetenz zu gewährleisten. Wenden Sie sich daher an: